

直线轴承

加长中间法兰不锈钢型(树脂保持架) SLMKC...UU-SLMKC12UUSLHMSW12

参数信息:

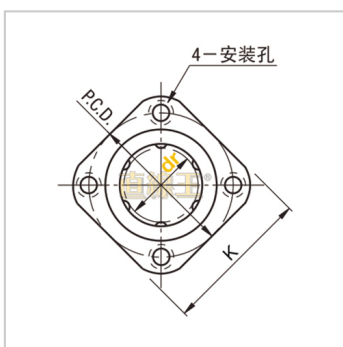
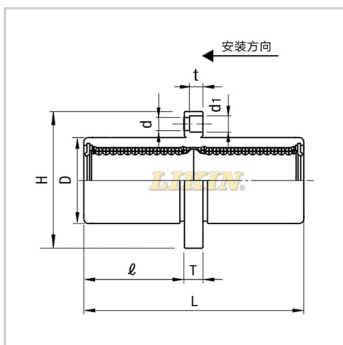

型号:

LIKIN直线王: SLMKC12
UU

MISUMI: SLHMSW
12

主要尺寸和公差(mm)

:

dr: 12

公差: 0-0.010

D: 21

公差: 0-0.016

L: 57

公差: ±0.3

: 25.5

H: 42

T: 6

d: 4.5

d1: 7.5

t: 4.1

P.C.D.: 32

K: 32

垂直度: 0.015

滚珠列数: 4

基本额定负载:

C(动)N: 813

Co(静)N: 1570

重量:

(g): 90

