

直线轴承

加长中间法兰不锈钢型(树脂保持架) SLMKC...UU-SLMKC10UUSLHMSW10

参数信息:

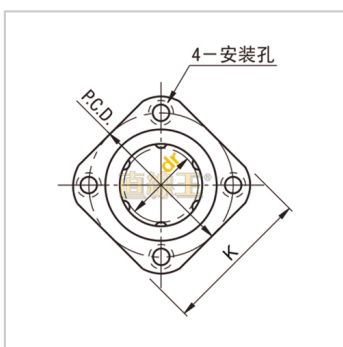
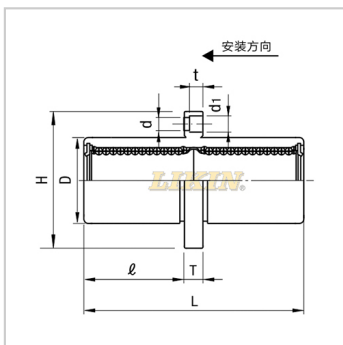

型号:

LIKIN直线王: SLMKC10
UU

MISUMI: SLHMSW
10

主要尺寸和公差(mm)

:

dr:	10
公差:	0 -0.010
D:	19
公差:	0 -0.016
L:	55
公差:	± 0.3
:	24.5
H:	40
T:	6
d:	4.5
d1:	7.5
t:	4.1
P.C.D.:	29
K:	30
垂直度:	0.015

滚珠列数: 4

基本额定负载:

C(动)N: 588

Co(静)N: 1100

重量:

(g): 78

