

直线轴承

加长导向方法兰不锈钢型(不锈钢保持架) SLMKP...LGA-SLMKP13LGASLHISWS13

参数信息:

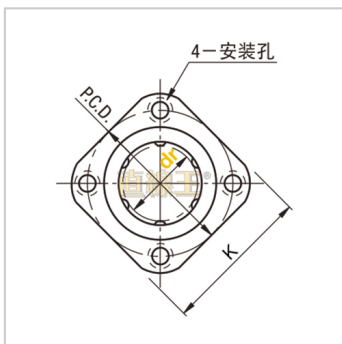
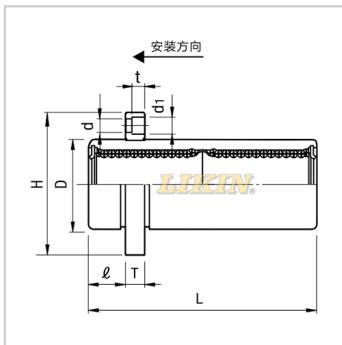

型号:

LIKIN直线王:	SLMKP13 LGA
MISUMI:	SLHISWS 13

主要尺寸和公差(mm)  
:

dr:	13
公差:	0-0.010
D:	23
公差:	0-0.018
L:	61
公差:	±0.3
:	6
H:	43
T:	6
d:	4.5
d1:	7.5
t:	4.1
P.C.D.:	33
K:	34
垂直度:	0.015
滚珠列数:	4

基本额定负载:

C(动)N:	813
Co(静)N:	1570

重量:

(g):	108
------	-----

