

直线轴承

亚标加长法兰不锈钢型(不锈钢保持架) SLMK...LGA-SLMK12LGASLHFSWS12

参数信息:

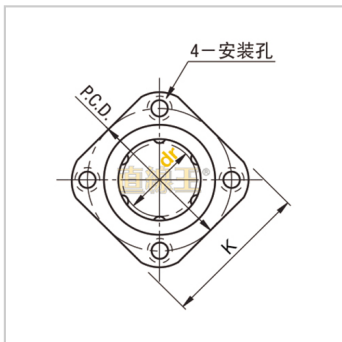
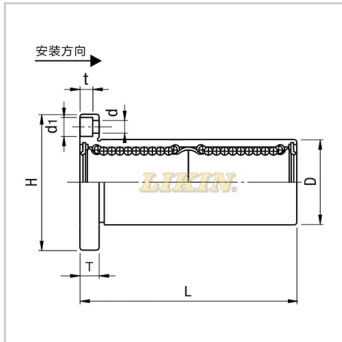

型号:

LIKIN直线王:	SLMK12LGA
MISUMI:	SLHFSWS12

主要尺寸和公差(mm):

dr:	12
公差:	0-0.010
D:	21
公差:	0-0.018
L:	57
公差:	±0.3
H:	42
T:	6
d:	4.5
d1:	7.5
t:	4.1
P.C.D.:	32
K:	32
垂直度:	0.015
滚珠列数:	4

基本额定负载:

C(动)N:	813
Co(静)N:	1570

重量:

(g):	90
------	----

: